

***Air Lift*1000**

by AIR LIFT®

**Kits 60763,
60774, 60783,
60797, 60798,
60897**

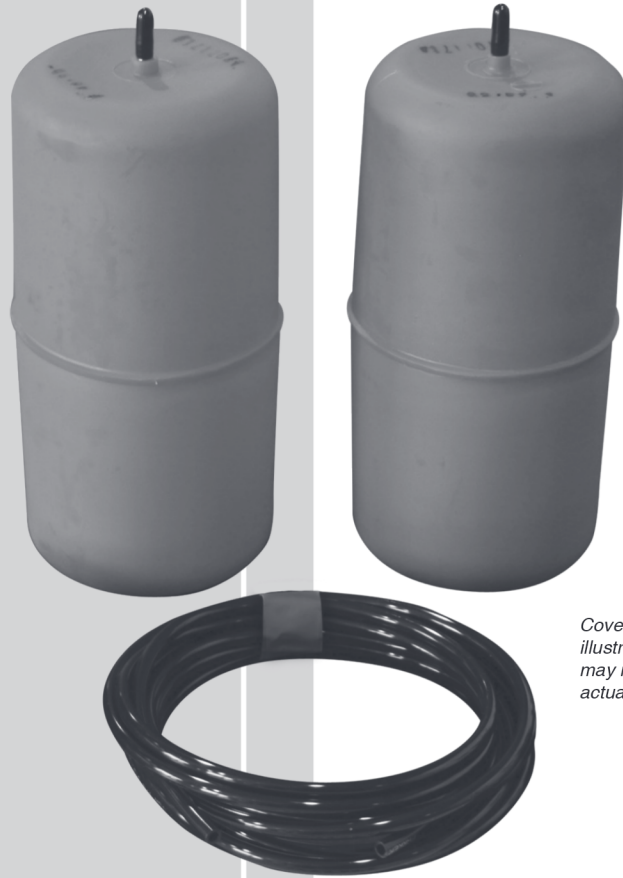

*Cover
illustration
may not depict
actual kit.*



INSTALLATION GUIDE

For maximum effectiveness and safety, please read these instructions completely before proceeding with installation.

Failure to read these instructions can result in an incorrect installation.

TABLE OF CONTENTS

Introduction	2
Important Safety Notice	2
Notation Explanation	2
Hardware and Tools Lists	3
Hardware List	3
Tools List	3
Installing the Air Lift1000 System	3
Important Note	3
Section A Installation	3
Section B Installation	4
Section C Installation	5
Installing the Air Line	6
Tee Air Line Routing	6
Dual Air Line routing	7
Checking for Leaks	8
Fixing Leaks	8
Before Operating	9
Installation Checklist	9
Post-installation checklist	9
Product Use, Maintenance and Servicing	10
Suggested Driving Pressure and Maximum Air Pressure	10
Maintenance Guidelines	10
Operating Tips	10
Troubleshooting Guide	10
Frequently Asked Questions	11
Tuning the Air Pressure	11
Guidelines for Adding Air	12
Choosing the Right On-Board Air Compressor System . . .	13
Limited Warranty and Return Policy	14
Replacement Information	15
Contact Information	15
Template	16



Introduction

The purpose of this publication is to assist with the installation, maintenance and troubleshooting of the Air Lift 1000 air spring kit.

It is important to read and understand the entire installation guide before beginning installation or performing any maintenance, service or repair. The information here includes a hardware list, tools list, step-by-step installation information, maintenance guidelines and operating tips.

Air Lift Company reserves the right to make changes and improvements to its products and publications at any time. Contact Air Lift Company at (800) 248-0892 or visit us online at www.airliftcompany.com for the latest version of this manual.

IMPORTANT SAFETY NOTICE

The installation of this kit does not alter the Gross Vehicle Weight Rating (GVWR) or payload of the vehicle. Check your vehicle's owner's manual and do not exceed the maximum load listed for your vehicle.

Gross Vehicle Weight Rating: The maximum allowable weight of the fully loaded vehicle (including passengers and cargo). This number — along with other weight limits, as well as tire, rim size and inflation pressure data — is shown on the vehicle's Safety Compliance Certification Label.

Payload: The combined, maximum allowable weight of cargo and passengers that the truck is designed to carry. Payload is GVWR minus the Base Curb Weight.

NOTATION EXPLANATION

Hazard notations appear in various locations in this publication. Information which is highlighted by one of these notations must be observed to help minimize risk of personal injury or possible improper installation which may render the vehicle unsafe. Notes are used to help emphasize areas of procedural importance and provide helpful suggestions. The following definitions explain the use of these notations as they appear throughout this guide.

 DANGER

INDICATES IMMEDIATE HAZARDS WHICH WILL RESULT IN SEVERE PERSONAL INJURY OR DEATH.

 WARNING

INDICATES HAZARDS OR UNSAFE PRACTICES WHICH COULD RESULT IN SEVERE PERSONAL INJURY OR DEATH.

 CAUTION

INDICATES HAZARDS OR UNSAFE PRACTICES WHICH COULD RESULT IN DAMAGE TO THE MACHINE OR MINOR PERSONAL INJURY.

NOTE

Indicates a procedure, practice or hint which is important to highlight.

HARDWARE LIST

Item	Part #	Description.....Qty
A	*	Air spring..... 2
B	09447	Protector 2
C	20315	15' Hose 1
D	10638	Air line clamp 6
E	10466	Zip tie 2
F	21230	Valve cap 2
G	21233	5/16" Hex nut 4
H	21234	Rubber washer..... 2
I	18411	5/16" Star washer..... 2
J	18405	5/16" Flat washer 2
K	21236	Barbed tee 1
L	21455	Valve 2

TOOLS LIST

Description..... Qty
Hoist or floor jacks 2
Safety stands..... 1
Safety glasses 1
Air compressor or compressed air source..... 1
Spray bottle with dish soap/water solution 1

*Air spring varies per specific kit number.



Missing or damaged parts? Call Air Lift customer service at (800) 248-0892 for a replacement part.

Installing the Air Lift 1000 System

IMPORTANT NOTE

This kit fits many different vehicles. Please consult the following listings for the appropriate installation section for your particular vehicle.

Section A: General Motors A (Century, Celebrity, Cutlass Cierra 6000) and X (Skylark, Citation, Omega, Phoenix) front wheel drive, with solid rear axle cars; Ford, Lincoln, Mercury full size and mid-size cars; Chevy Lumina APV, Olds Silhouette, and Pontiac Transport; Nissan Pathfinder; Isuzu Trooper, Amigo, and Vehicross

Section B: Camaro, Firebird, Monza, Skyhawk, Starefire, Astre, Sunbird, and Vega

Section C: General Motors E (Toronado, Riviera, El Dorado, SeVille) and H (LeSabre, Electra, Park Ave, DeVille, Eighty-Eight, Ninety-Eight, and Bonneville) Cars; Kia Sedona Van; Nissan Morano, Toyota Scion XB.

SECTION A INSTALLATION

1. Some Ford, Lincoln, and Mercury models come equipped with a rubber sleeve inside of the rear coil springs. This needs to be removed prior to proceeding with the installation. It can either be cut out or pulled out with vise grips.
2. Jack up the rear of the vehicle or raise on a hoist. Support the frame with safety stands. Lower the axle or raise the body of the vehicle until the suspension is fully extended (fig. 1).
3. If necessary, additional clearance between the coil may be obtained by removing the shock absorbers from the lower mountings and lowering the suspension an additional two inches.



OBSERVE THE TENSION ON THE BRAKE LINE. DO NOT STRAIN.

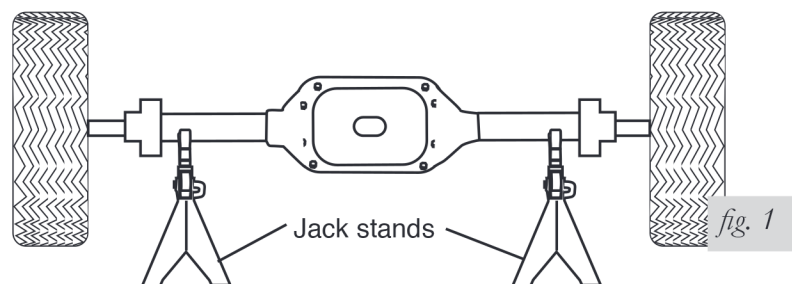

4. Remove the plastic cap from the barbed stem on the end of the air spring and exhaust all the air from the air spring by rolling it up towards the barbed stem. Replace the cap so that the air spring holds its flat shape. Form the air spring into a hot dog bun shape (fig. 2).

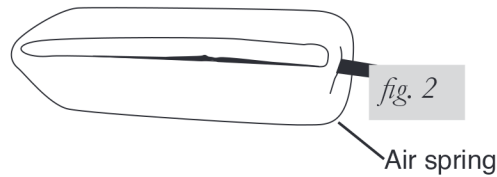

5. Insert the stem end of the air spring into the lowest opening of the coil (valve stem up). Push the air spring into the coil spring by hand or with a blunt object such as a spoon-type tire iron (fig. 3).
6. When the air spring is completely within the coil, remove the cap and allow the air spring to assume its original shape.
7. Push the air spring to the bottom of the coil and insert the protector on top of the air spring (fig. 4).
8. Continue with "Installing the Air Line."

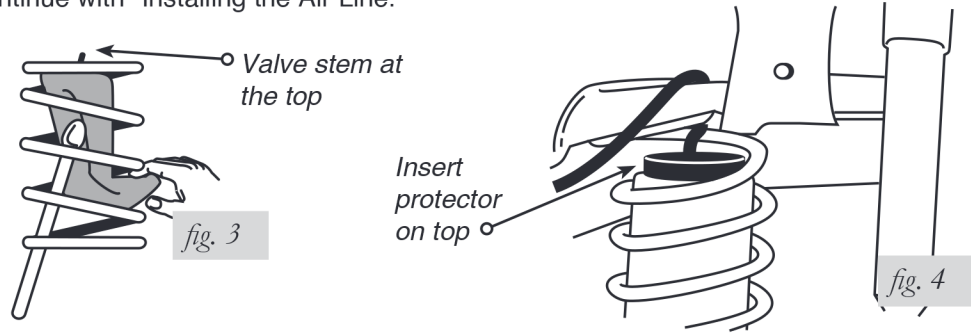

SECTION B INSTALLATION

1. Jack up the rear of the vehicle or raise on a hoist. Support the frame with safety stands (see fig. 1).
2. Detach the shock absorber lower ends from the axle. Lower the axle or raise the body to permit the removal of the coil spring.
3. 1975 and up Vega, Monza, Starfire, Skyhawk, and Sunbird only:
 - a. Remove the upper bound bumper/cone assembly with coil spring (fig. 5). The bumper/cone assembly will not be reused, as the air spring replaces its function.
 - b. Cut out circle "C" on the template (see Template on page 11) and place onto the lower spring seat, holding it in position with a dab of grease. Center punch and drill a 1/2" hole in the marked location (fig. 6).

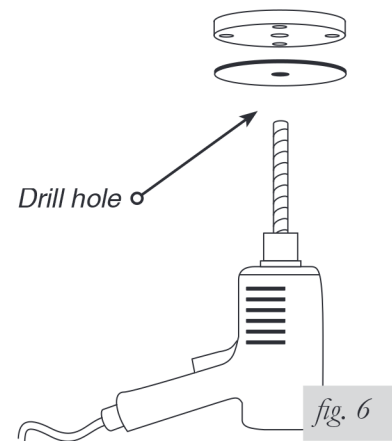
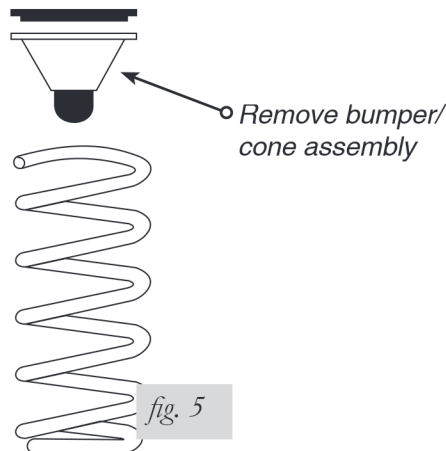

4. Insert the air spring into the coil with the stem down (fig. 7).
5. If removed, place the upper spring insulator on top of the coil spring. Index it so that the notch fits on the end of the spring.
6. Replace the coil springs and air spring assembly into the vehicle spring seats, insuring that the end of the spring is indexed properly into the notch in the seat.
7. Push the air spring to the top of the coil spring and insert the protector on top of the lower spring seat (fig. 8).
8. Continue with "Installing the Air Line."

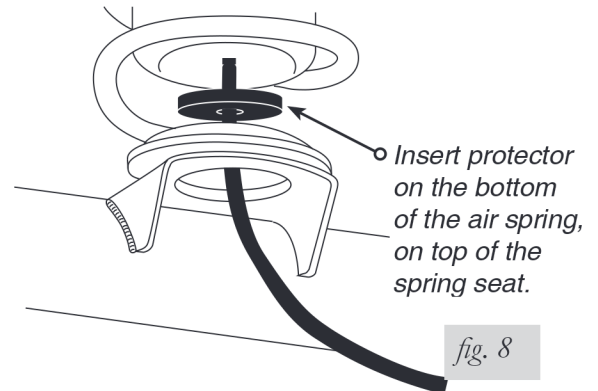
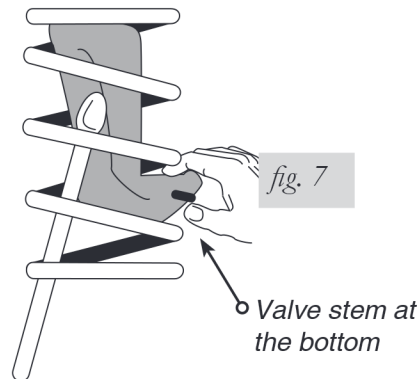

SECTION C INSTALLATION

1. Jack up the rear of the vehicle or raise on a hoist. Support the frame with safety stands. Lower the axle or raise body of the vehicle until the suspension is fully extended (see fig. 1).
2. Some of the vehicles in this section do not have a hole in the lower spring. Cut out circle "D" on the template and place into the lower spring seat, holding it in place with a dab of grease. Center punch and drill a 3/4" hole in the marked location.
3. Remove the plastic cap from the barbed stem on the end of the air spring and exhaust all the air from the air spring by rolling it up towards the barbed stem. Replace the cap so that the air spring holds its flat shape. Form the air spring into a hot dog bun shape.
4. Insert the air spring into the coil with the stem down. Push the air spring into the coil spring by hand or carefully with a blunt object such as a spoon-type tire iron (see fig. 7).
5. When the air spring is completely within the coil, remove the cap and allow it to assume its original shape.
6. Push the air spring to the top of the coil and insert the protector on the bottom of the air spring (see fig. 8).
7. Continue with "Installing the Air Line."

INSTALLING THE AIR LINE

Tee air line installation is recommended unless weight in the vehicle varies from one side to the other and unequal pressures are needed to level the load. Dual air lines are used in this case.

TEE AIR LINE ROUTING

CAUTION

TO PREVENT THE AIR LINE FROM MELTING, MAINTAIN AT LEAST 8" FROM THE EXHAUST SYSTEM TO THE AIR LINE.

1. Locate the desired tee location on the frame rail or cross member. Determine and cut adequate length of air line to reach from tee to the left and right side air springs.

CAUTION

LEAVE SUFFICIENT AIR LINE SLACK TO PREVENT ANY STRAIN ON THE FITTING DURING AXLE MOTIONS.

2. Slide an air line clamp onto the air line.
3. Push the air line over one side of the tee until all the barbs are covered. With a pair of pliers, slide the air line clamp forward until it fully covers the barbed section. Repeat entire procedure for other leg of the tee (fig. 9).
4. Route the air line along the cross member and either the lower control arm or the upper spring seat to the air spring.
5. Insert the air line through the spring seat and protectors.

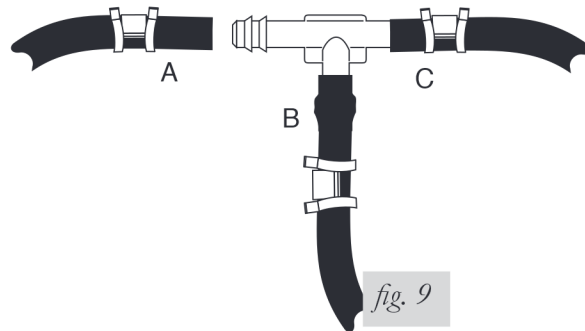

Use this procedure for all air line connections:

- a. Slide the air line clamp onto the air line.
- b. Push the air line over the barbed stem.
- c. Compress the ears on the air line clamp with pliers and slide it forward to fully cover the barbed section.

6. Push the air line onto the stem, covering all the barbs (fig. 10). With the pliers, slide the air line clamp upward until it fully covers the barbed section.
7. Push the remaining air line over the last fitting on the tee and route it along the frame to the desired inflation valve location. Attach the air line with plastic straps or wire.
8. Select a location for the inflation valve in the gas cap well, the trunk, rear bumper, fender flange or behind license plate, insuring that the valve will be protected and accessible with an air hose (fig. 11).

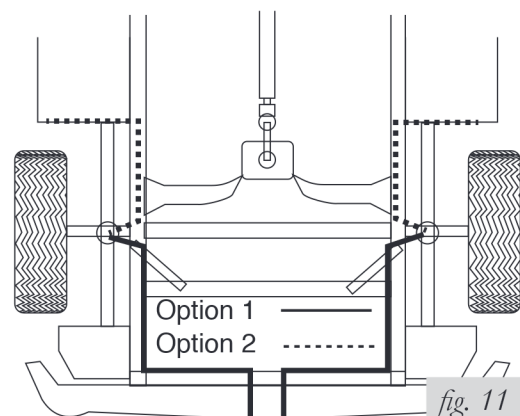
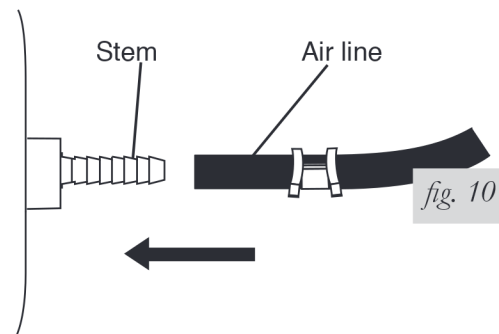

9. Drill a 5/16" hole for the inflation valve and mount as shown (fig. 12). The rubber washer serves as an outside weather seal.
10. Slide the air line clamp over the air line. Push the air line onto the fitting covering all barbs. Using pliers, slide the air line clamp forward until it fully covers the barbed section (fig. 13).

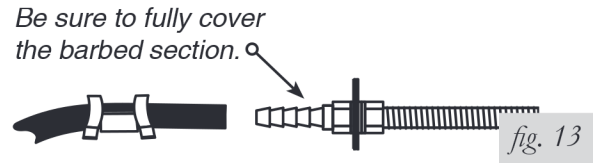
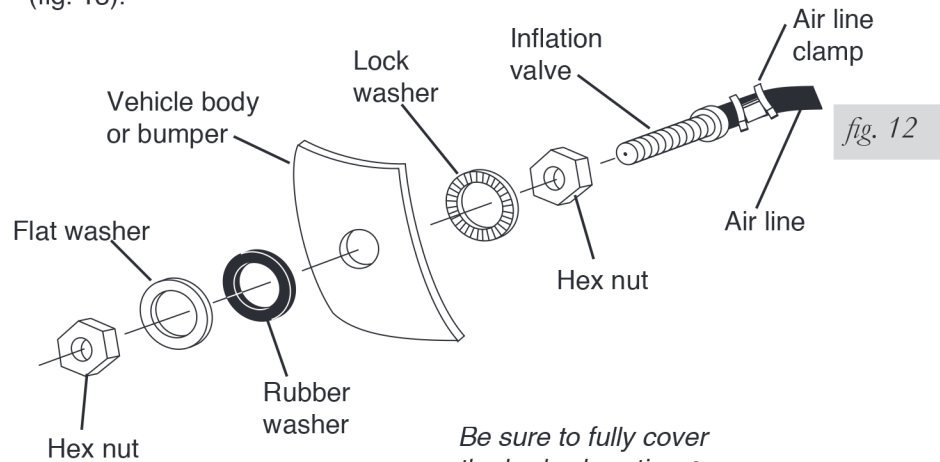

11. Raise the axle or lower the vehicle body until the air springs lightly touch the upper spring seat and lower spacers.
12. Check tail pipe clearance and insure that it is at least 2-3 inches from air spring. If necessary, loosen clamps and rotate or move to obtain additional clearance. If heat shield is provided, install. Attach shock absorbers if removed earlier in the installation.

CAUTION

DO NOT INFLATE AIR SPRINGS BEFORE READING THE MAINTENANCE AND OPERATION SECTION.

13. Continue to "Checking for Leaks".

DUAL AIR LINE ROUTING

CAUTION

TO PREVENT AIR LINE FROM MELTING, KEEP IT AT LEAST 8" FROM EXHAUST SYSTEM.

1. Select a location for the inflation valves in the rocker panel flange, or rear bumper, assuring that each valve will be protected and accessible with an air hose.
2. Determine and cut adequate length of air line to reach from valve location to left side air spring.

CAUTION

LEAVE SUFFICIENT AIR LINE SLACK TO PREVENT ANY STRAIN ON FITTING DURING AXLE MOTIONS.

3. Insert the air line through the spring seat and protectors.
4. Slide air clamp onto the cut air line.
5. Push the air line onto the stem, covering all the barbed section (see fig. 10). With pliers slide the air line clamp forward until it fully covers barbed section.
6. Repeat process for right side.
7. Drill a 5/16" hole for inflating valves and mount as illustrated. Rubber washer is for outside weather seal (see fig. 12).
8. Route air line along control arm and frame to inflation valve location and cut off excess.

9. Slide a clamp onto the air line and push the air line over the fitting, covering all the barbs. With pliers slide the air line clamp forward until it fully covers the barbed section (see fig. 13).
10. Raise axle or lower body until air springs lightly touch the upper/lower spring seat and protectors.
11. Check tail pipe clearance and insure that it is at least 2-3 inches from air springs. If necessary, loosen clamps and rotate or move to obtain additional clearance. If heat shields are supplied, install them. Attach shock absorbers if removed earlier in the installation.

CAUTION

DO NOT INFLATE AIR SPRINGS BEFORE READING THE MAINTENANCE AND OPERATION SECTION.

CHECKING FOR LEAKS

1. Inflate the air spring to 35 PSI.
2. Spray all connections and the inflation valves with a solution of 1/5 liquid dish soap and 4/5 water. Spot leaks easily by looking for bubbles in the soapy water.
3. After the test, deflate the springs to the minimum pressure required to restore the system to normal ride height. Do not deflate to lower than 5 PSI.
4. Check the air pressure again after 24 hours. A 2 - 4 PSI loss after initial installation is normal. Retest for leaks if the loss is more than 5 lbs.

FIXING LEAKS

1. If there is a problem with the inflation valve:
 - a. Check the valve core by tightening it with a valve core tool.
 - b. Check the air line by removing the air line from the barbed type fitting. Cut the air line off a few inches in front of the fitting and use a pair of pliers or vice grips to pull/twist the air line off of the fitting.

CAUTION

DO NOT CUT OFF THE AIR LINE COMPLETELY AS THIS WILL USUALLY NICK THE BARB AND RENDER THE FITTING USELESS.

2. If the preceding steps have not resolved the problem, call Air Lift customer service at (800) 248-0892.

Before Operating

INSTALLATION CHECKLIST (To be completed by installer)

- Clearance test — Inflate the air springs to 30 PSI and ensure there is at least 1/2" clearance around each bellow, away from anything that might rub against them. Be sure to check the tire, brake drum, frame, shock absorbers and brake cables.
- Leak test before road test — Inflate the air springs to 30 PSI, check all connections for leaks with a soapy water solution. See *Checking for Leaks* on how to spot leaks. All leaks must be eliminated before the vehicle is road tested.
- Heat test — Be sure there is sufficient clearance from any heat sources — at least 6" for air springs and air lines. If a heat shield was included in the kit, install it. If there is no heat shield, but one is required, call (800) 248-0892.
- Fastener test — Recheck all bolts for proper torque. Re-torque after 100 miles.
- Road test — The vehicle should be road tested after the preceding tests. Inflate the air springs to 25 PSI (30 PSI if the vehicle is loaded). Drive the vehicle 10 miles and recheck for clearance, loose fasteners and air leaks.
- Operating instructions — If professionally installed, the installer should review the *Product Use, Maintenance and Servicing* section with the owner. Be sure to provide the owner with all of the paperwork which came with the kit.

Technician's Signature _____

Date _____

POST-INSTALLATION CHECKLIST

- Overnight leak down test — Recheck air pressure after the vehicle has been used for 24 hours. If the pressure has dropped more than 5 PSI, then there is a leak that must be fixed. Either fix the leak yourself or return to the installer for service.
- Air pressure requirements — Regardless of load, the air pressure should always be adjusted to maintain ride height at all times.
- Thirty day or 500 mile test — Recheck the air spring system after 30 days or 500 miles, whichever comes first. If any part shows signs of rubbing or abrasion, the source should be identified and moved, if possible. If it is not possible to relocate the cause of the abrasion, the air spring may need to be remounted. If professionally installed, the installer should be consulted. Check all fasteners for tightness.

Product Use, Maintenance and Servicing

Minimum Air Pressure	Maximum Air Pressure
5 PSI	35 PSI
FAILURE TO MAINTAIN CORRECT MINIMUM PRESSURE (OR PRESSURE PROPORTIONAL TO LOAD), BOTTOMING OUT, OVER-EXTENSION OR RUBBING AGAINST ANOTHER COMPONENT WILL VOID THE WARRANTY.	

MAINTENANCE GUIDELINES

NOTE

By following these steps, vehicle owners will obtain the longest life and best results from their air spring.

1. Check the air pressure weekly.
2. Always maintain normal ride height. Never inflate beyond 35 PSI.
3. If you develop an air leak in the system, use a soapy water solution to check all air line connections and the inflation valve core, before deflating and removing the spring.
4. When increasing load, always adjust the air pressure to maintain normal ride height. Increase or decrease pressure from the system as necessary to attain normal ride height for optimal ride and handling. Remember that loads carried behind the axle (including tongue loads) require more leveling force (pressure) than those carried directly over the axle.

CAUTION

FOR YOUR SAFETY AND TO PREVENT DAMAGE TO YOUR VEHICLE, DO NOT EXCEED MAXIMUM GROSS VEHICLE WEIGHT RATING (GVWR), AS INDICATED BY THE VEHICLE MANUFACTURER. ALTHOUGH YOUR AIR SPRINGS ARE RATED AT A MAXIMUM INFLATION PRESSURE OF 35 PSI, THE AIR PRESSURE ACTUALLY NEEDED IS DEPENDENT ON YOUR LOAD AND GVWR.

5. Always add air to the springs in small quantities, checking the pressure frequently. Cylinders require less air volume than a tire and inflate quickly.
6. Should it become necessary to raise the vehicle by the frame, make sure the system is at a minimum pressure (5 PSI) to reduce tension on the suspension/brake components. Use of on-board leveling systems do not require deflation or disconnection.

OPERATING TIPS

1. Inflate your air springs to 35 PSI before adding the payload. This will allow the air cylinder to properly mesh with the coil spring. After the vehicle is loaded, adjust your air pressure down to level the vehicle and for ride comfort.
2. When carrying a payload it will be helpful to increase the tire inflation pressure in proportion to any overload condition. We recommend a 2 PSI increase above normal for each 100 lbs additional load on the axle.

TROUBLESHOOTING GUIDE

1. Leak test the air line connections.
2. Inspect the air lines to be sure none are pinched. Tie straps may be too tight. Loosen or replace the strap and replace leaking components.
3. Inspect the air line for holes and cracks. Replace as needed.
4. Look for a kink or fold in the air line. Reroute as needed.

If the preceding steps do not solve the problem, it is possibly caused by a failed air spring — either a factory defect or an operating problem. Please call Air Lift at (800) 248-0892 for assistance.

FREQUENTLY ASKED QUESTIONS

Q. Will installing air springs increase the weight ratings of a vehicle?

No. Adding air springs will not change the weight ratings (GAWR, GCWR and/or GVWR) of a vehicle. Exceeding the GVWR is dangerous and voids the Air Lift warranty.

Q. Is it necessary to keep air in the air springs at all times and how much pressure will they need?

For LoadLifter 5000 Ultimate, the recommended minimum air pressure is 5 PSI, but it can safely be run at zero air pressure.

Q. Is it necessary to add a compressor system to the air springs?

No. Air pressure can be adjusted with any type of compressor as long as it can produce sufficient pressure to service the springs. Even a bicycle tire pump can be used, but it's a lot of work.

Q. How long should air springs last?

If the air springs are properly installed and maintained they can last indefinitely.

Q. Will raising the vehicle on a hoist for service work damage the air springs?

No. The vehicle can be lifted on a hoist for short-term service work such as tire rotation or oil changes. However, if the vehicle will be on the hoist for a prolonged period of time, support the axle with jack stands in order to take the tension off of the air springs.

TUNING THE AIR PRESSURE

Pressure determination comes down to three things — level vehicle, ride comfort, and stability.

1. Level vehicle

If the vehicle's headlights are shining into the trees or the vehicle is leaning to one side, then it is not level (fig. 2.1). Raise the air pressure to correct either of these problems and level the vehicle.

2. Ride comfort

If the vehicle has a rough or harsh ride it may be due to either too much pressure or not enough (fig. 2.2). Try different pressures to determine the best ride comfort.

3. Stability

Stability translates into safety and should be the priority, meaning the driver may need to sacrifice a perfectly level and comfortable ride. Stability issues include roll control, bounce, dive during braking and sponginess (fig. 2.3). Tuning out these problems usually requires an increase in pressure.



Bad headlight aim *fig. 2.1*



Rough ride *fig. 2.2*

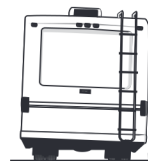

Sway and body roll *fig. 2.3*

GUIDELINES FOR ADDING AIR

1. Start with the vehicle level or slightly above.
2. When in doubt, always add air.
3. If the front of the vehicle dives while braking, increase the pressure in the front air bags, if equipped.
4. If it is ever suspected that the air bags have bottomed out, increase the pressure (fig. 2.4).
5. Adjust the pressure up and down to find the best ride.
6. If the vehicle rocks and rolls, adjust the air pressure to reduce movement.
7. It may be necessary to maintain different pressures on each side of the vehicle. Loads such as water, fuel, and appliances will cause the vehicle to be heavier on one side (fig. 2.5). As much as a 50 PSI difference is not uncommon.



Bottoming out

fig. 2.4

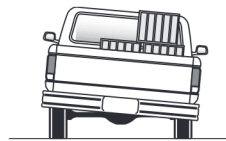

Unlevel

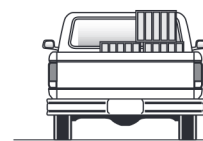

Level

fig. 2.5

Choosing the Right On-Board Air Compressor System

60 DAY NO QUESTIONS ASKED, MONEY-BACK GUARANTEE

TWO YEAR COMPRESSOR SYSTEM WARRANTY

Add an on-board air compressor system to inflate and deflate your air springs with the touch of a button — from inside or outside of the vehicle.

- For convenient, on-the-go control of your air springs, add an Air Lift on-board air compressor system.
- Air Lift on-board air compressor systems eliminate the search for gas stations that have a working compressor, saving you time, energy and money.
- All systems include a compressor, controller and all parts needed for easy installation.

1. Choose single or dual path inflation (see illustrations at right)

2. Choose wireless or analog control

- **Wireless:** Control your air springs from inside or outside the vehicle. Easiest installation - no wires to the cab.
- **Analog:** In-cab control of your air springs. Economically priced.

3. Choose heavy or standard duty compressor

- **Standard duty:** A standard duty compressor will work well for most customers who use their system on an intermittent basis.
- **Heavy duty:** For daily use, consider the heavy duty compressor - it inflates faster and more quietly than the standard compressor.

Visit www.airliftcompany.com for more detailed info on compressor systems.

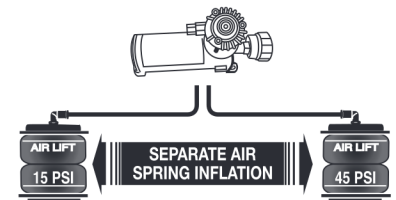

Dual path systems Air springs are controlled separately to allow for different air pressure from side-to-side. Perfect for uneven or top-heavy loads.

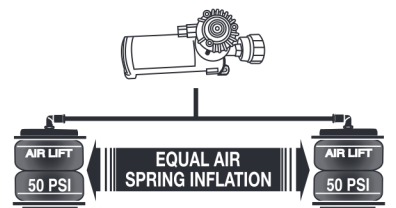

Single path systems Two springs will inflate at the same time. Good for loads that are evenly distributed from left-to-right or front-to-back.

WIRELESS

ANALOG

DUAL PATH

WirelessAIR™



- Easy installation
- Includes heavy duty compressor

P/N 72000

LoadCONTROLLER™

Dual

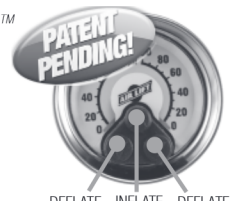

Compact, economically priced control.

P/N Standard Duty Compressor 25850; P/N Heavy Duty Compressor 25854

SINGLE PATH

WirelessONE™



- Easy installation
- Includes standard duty compressor

P/N 25870

LoadCONTROLLER™

Single

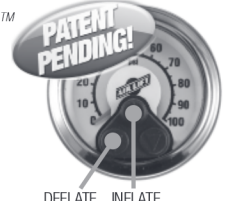

Compact, economically priced control.

P/N Standard Duty Compressor 25852; P/N Heavy Duty Compressor 25856

Limited Warranty and Return Policy

WHAT THIS WARRANTY COVERS

Air Lift Company provides a warranty to the original purchaser of its Load Support Products, for the periods of time listed below, by product line, from the date of original purchase, that the products will be free from defects in workmanship and materials when used on cars and trucks as specified by Air Lift Company and under normal operating conditions, subject to the requirements and exclusions set forth below.

WHAT THIS WARRANTY DOES NOT COVER

The warranty does not apply to products that have been improperly applied, improperly installed, or which have not been maintained in accordance with installation instructions furnished with all products. This warranty does not apply and is void if damage or failure is caused by: accident, abuse, misuse (including but not limited to racing or off-road activities or commercial use), abnormal use, faulty installation, liquid contact, fire, earthquake or other external cause; operating the product outside Air Lift Company's instructions, specifications or guidelines; or service, alteration, maintenance or repairs performed by anyone other than Air Lift Company to the product from its purchased condition. This warranty also does not apply to: consumable parts, such as batteries; cosmetic damage, including but not limited to scratches or dents; defects caused by normal wear and tear or otherwise due to the normal aging of the product, or if any serial or identification number has been removed or defaced from the product. Air Lift Company reserves the right to change the design of any product without assuming any obligation to modify any product previously manufactured.

LIMITATION OF LIABILITY

To the extent permitted by law, this warranty and the remedies set forth herein are exclusive and in lieu of all other warranties, remedies and conditions, whether oral, written, statutory, express or implied. AIR LIFT COMPANY DISCLAIMS ALL STATUTORY AND IMPLIED WARRANTIES, INCLUDING WITHOUT LIMITATION, WARRANTIES OF MERCHANTABILITY AND FITNESS FOR A PARTICULAR PURPOSE AND WARRANTIES AGAINST HIDDEN OR LATENT DEFECTS TO THE EXTENT PERMITTED BY LAW. To the extent such warranties cannot be disclaimed, such implied warranties shall apply only for the warranty period specified above. Please note that some states do not allow limitation on how long an implied warranty (or condition) lasts. So the above limitation may not apply to you.

Except as provided in this warranty and to the extent permitted by law, Air Lift Company shall not be liable for any direct, special, incidental or consequential damages resulting from any breach of warranty or condition, or arising in connection with the sale, use or repair of air lift products, or under any other legal theory, including but not limited to loss of use, loss of revenue, loss of actual or anticipated profits, loss of the use of money, loss of business, loss of opportunity, loss of goodwill, and loss of reputation. Air Lift Company's maximum liability shall not in any case exceed the purchase price paid by you for the Air Lift product. Please note that some states do not allow the exclusion or limitation of incidental or consequential damages, so the above limitation or exclusion may not apply to you.

HOW TO GET SERVICE

If a defect in workmanship or materials causes your Air Lift product to become inoperable within the warranty period, before returning any defective product, call Air Lift Company at (800) 248-0892 in the U.S. and Canada (elsewhere, (517) 322-2144) to obtain a Returned Materials Authorization (RMA) number. The consumer shall be responsible for removing (labor charges) the defective product from the vehicle and returning it, shipping costs prepaid, to Air Lift Company for verification. Returns to Air Lift Company must be postage prepaid and sent to: Air Lift Company • 2727 Snow Road • Lansing, MI • 48917. You must prove to the satisfaction of Air Lift Company the date of original purchase of your Air Lift product. You must also enclose the RMA number and a return address. A minimum \$10 shipping and handling charge will apply to all warranty claims. You must also pack the product to minimize the risk of it being damaged in transit. If we receive a product in damaged condition as the result of shipping, we will notify you and you must seek a claim with the shipper.

WHAT AIR LIFT COMPANY WILL DO

If you submit a valid claim to Air Lift Company during the warranty period, Air Lift Company will, at its option, repair your Air Lift product or furnish you with a new or rebuilt product. Air Lift Company will not reimburse you for repairs or replacement parts provided by other parties. Your repaired or replacement Air Lift product will be returned to you (subject to payment of the required warranty claim shipping and handling charge) and it will be covered under the warranty for the balance of the warranty period, if any. When a product or part is replaced, any replacement item becomes your property and the replaced item becomes property of Air Lift Company. You are responsible for installation/reinstallation (labor charges) of the product.

HOW THE LAW RELATES TO THIS WARRANTY

This warranty gives you specific legal rights and you may also have other rights which vary from state to state. By this warranty, Air Lift Company does not limit or exclude your rights except as allowed by law. To fully understand your rights, you should consult the laws of your state.

SPECIFIC LOAD SUPPORT WARRANTY PERIODS BY PRODUCT LINE

LoadLifter 5000™ Ultimate.....	Lifetime Limited	WirelessAIR™.....	2 Year Limited
LoadLifter 5000™.....	Lifetime Limited	WirelessONE™.....	2 Year Limited
RideControl™.....	Lifetime Limited	LoadController™ Single and Dual.....	2 Year Limited
Air Lift 1000™.....	Lifetime Limited	LoadController™ I and II.....	2 Year Limited
AirCell™.....	Lifetime Limited	SmartAir™ II.....	2 Year Limited
SlamAir™.....	Lifetime Limited	Other Accessories.....	2 Year Limited

Replacement Information

If you need replacement parts, contact the local dealer or call Air Lift customer service at (800) 248-0892. Most parts are immediately available and can be shipped the same day.

Contact Air Lift Company customer service at (800) 248-0892, first if:

- Parts are missing from the kit.
- Need technical assistance on installation or operation.
- Broken or defective parts in the kit.
- Wrong parts in the kit.
- Have a warranty claim or question.

Contact the retailer where the kit was purchased:

- If it is necessary to return or exchange the kit for any reason.
- If there is a problem with shipping if shipped from the retailer.
- If there is a problem with the price.

Contact Information

If you have any questions, comments or need technical assistance, contact our customer service department by calling (800) 248-0892, Monday through Friday. For calls from outside the USA or Canada, our local number is (517) 322-2144.

For inquiries by mail, our address is PO Box 80167, Lansing, MI 48908-0167. Our shipping address for returns is 2727 Snow Road, Lansing, MI 48917.

You may also contact us anytime by e-mail at sales@airliftcompany.com or on the web at www.airliftcompany.com.

Template

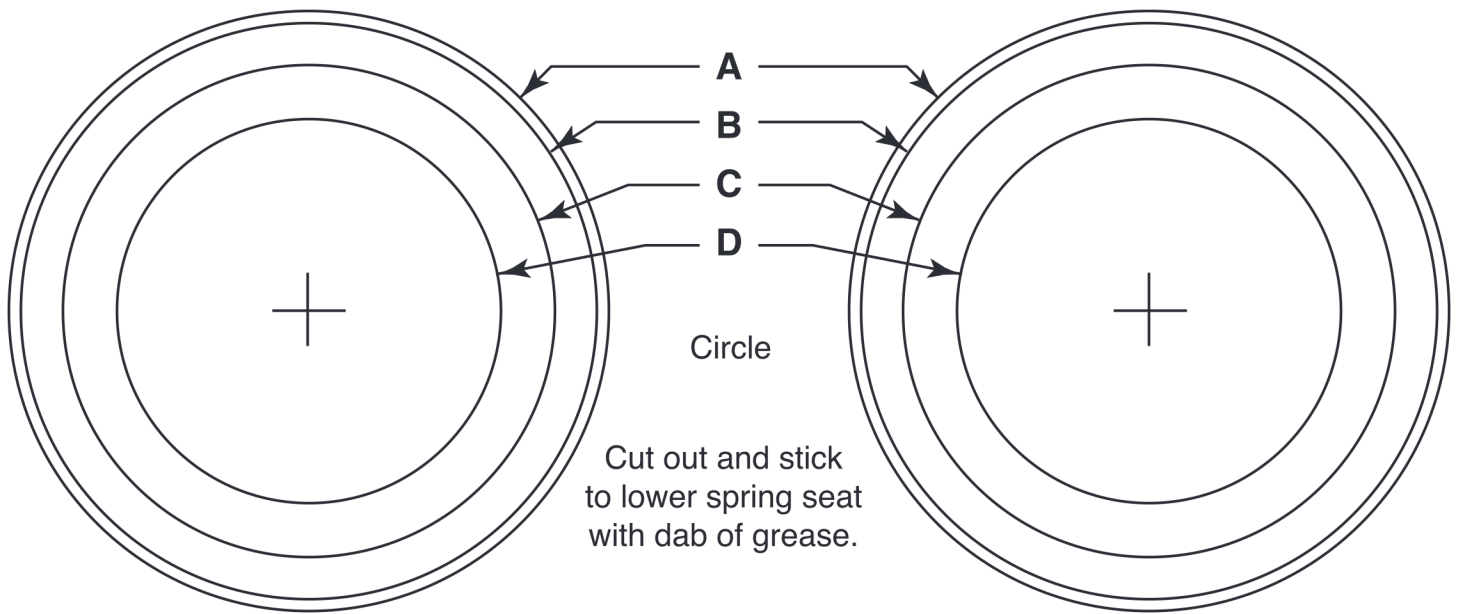

Need Help?

Contact our customer service department by calling (800) 248-0892, Monday through Friday. For calls from outside the USA or Canada, our local number is (517) 322-2144.

**Register your warranty online at
www.airliftcompany.com/warranty**



Thank you for purchasing Air Lift products — the professional installer's choice!

Air Lift Company • 2727 Snow Road • Lansing, MI 48917 or PO Box 80167 • Lansing, MI 48908-0167
Toll Free (800) 248-0892 • Local (517) 322-2144 • Fax (517) 322-0240 • www.airliftcompany.com

Printed in
the USA